

SPEED POST

**CENTRAL ANIMAL FACILITY
ALL INDIA INSTITUTE OAF MEDICAL SCIENCES
ANSARI NAGAR, NEW DELHI-110029**

Date: 16/10/2020

RE No. 02/ Racks (Stainless Steel)/CAF/2020-21 (Specification)

Sealed quotations are invited by post/bear from the reputed firms/manufacturers for the supply of the Racks (Stainless Steel) following/detailed overleaf items subjected to following terms & conditions:

- 1) Quotations should be reach this office on or before 19/11/2020 at 12.00 Noon and they will be opened Technical Bid & Price Bid on 19/11/2020 & 23/11/2020 at 03.00 P.M in the seminar room of central Animal Facility, New Delhi in form of the bidders present there. All the quotations received before the mentioned closing date and time will be entertained.
- 2) The bidder should care that the rates and amount are written in such a way that interpolation is not possible. Alteration/over writing, unless legibly attested by the bidder shall not be considered.
- 3) The make of the article(s) offered should invariably be quoted. Material confirming to the specifications should be quoted. The compliance report of specification should invariably be provided indicating the fulfillment of each parameter of the specifications.
- 4) Rates must be valid for 12 months from the date of opening of quotations.
- 5) Delivery prospects with definite period of delivery at destination must be indicated.
- 6) Each quotation should be accompanied with an EMD amounting to 30,000/- (Rupees Thirty Thousand Only) by way of DD/Pay order drawn in favor of The Director, AIIMS payable at New Delhi Cash/cheque will not be accepted. EMD deposited against other tender/quotations can't be considered for this rate enquiry. No interest is payable on EMD.
- 7) Quotations should be submitted in two bid systems containing two parts as detailed below Part-I Techno commercial bid in one sealed cover
Part-II Price bid/financial in one sealed cover. Both the sealed envelopes should then be put in one outer cover and superscripted as Rate Enquiry No 02/Racks (Stainless Steel)/CAF/2020-21, (Specification). Please note that prices should not be indicated in techno commercial bid. The prequalification documents including EMD should invariable be accompanied with the Techno commercial bid.
- 8) Quotations submitted without following two bid systems procedure as mentioned above will be summarily rejected.



डॉ. प्रदीप कुमार यादव / Dr. Pardeep Kumar Yadav
ज्योतिष पशु चिकित्सा अधिकारी / Senior Veterinary Officer
केंद्रीय पशु सुविधा / Central Animal Facility
अ.भा.आ.सं. नई दिल्ली-110029/AIIMS New Delhi-110029

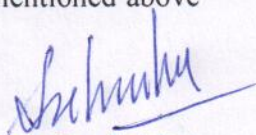

डॉ. श्याम सिंह चौहान / Dr. Shyam Singh Chauhan
प्रभारी-आचार्य / Professor-in-Charge
केंद्रीय पशु सुविधा / Central Animal Facility
अ.भा.आ.सं. नई दिल्ली-29/A.I.M.S., New Delhi-29

9) Technical bid will contain the following documents:

- a) Copy of latest sales tax/Service Tax registration Certificate/GST.
- b) Letter from manufacturer/principal.
- c) Earnest Money (DD/Pay order). No cash will be accepted against EMD
- d) Affidavit that the firm has not been black listed in the past by any hospital/organization.
- e) Quality assurance certificate like ISI 9001-2000/ISO 9002/FDA/CE or any other equivalent.
- f) List of the organizations supplied with the same equipments.
- g) Affidavit/undertaking that the firm is not supplying the same item at the lowest rate quoted in the tender/RE to any Govt. Organization or any other Institute (false clause).
- h) Guarantee/ Warrantee for 5 years of Rack with wheels (Repair or Replace).
- i) Polishing and Buffing of Racks every 20 month for 5 years
- j) Details of name of beneficiary, Accounts no of beneficiary, IFCS code of the bank & branch.
- k) Quality assurance certificate of 304 Stainless Steel make with AISI Mark.
- l) Stainless Steel Furniture Items GST HSN Code- 94021010 (18%) and also give the state code.
- m) Submission of sample of Racks Stainless Steel, after approval of the Price Bid.
- n) If you are not fulfilling the requirement for Guarantee/Warrantee (Repair or Replace), polishing and buffing otherwise firm has been counted in the **black listed**.

10) Price bid:

- a) Rates must be quoted for one year and Comprehensive Warranty/Guarantee from the date of satisfactory completion.
- b) Sales Tax/ Service Tax/ GST and other statutory levies should be shown separately and should not be included in the basic price otherwise it will not be considered.

Note: Quotations submitted with incomplete documents will be summarily rejected. The check list may be furnished properly and page no. may be mentioned against each serial number.



डॉ. प्रदीप कुमार यादव / Dr. Pardeep Kumar Yadav
वरिष्ठ पशु चिकित्सा अधिकारी / Senior Veterinary Officer
केंद्रीय पशु सुविधा / Central Animal Facility
अ.भा.आ.स.नई दिल्ली-110029/AIIMS New Delhi-110029



डॉ. श्याम सिंह चौहान / Dr. Shyam Singh Chauhan
प्रभारी-आचार्य / Professor-in-Charge
केंद्रीय पशु सुविधा / Central Animal Facility
अ.भा.आ.स., नई दिल्ली-29/A.I.I.M.S., New Delhi-29

Date: 16/10/2020

Racks (Stainless Steel) (Specification)

Specification: -

Quantity Required
20 (Approx)

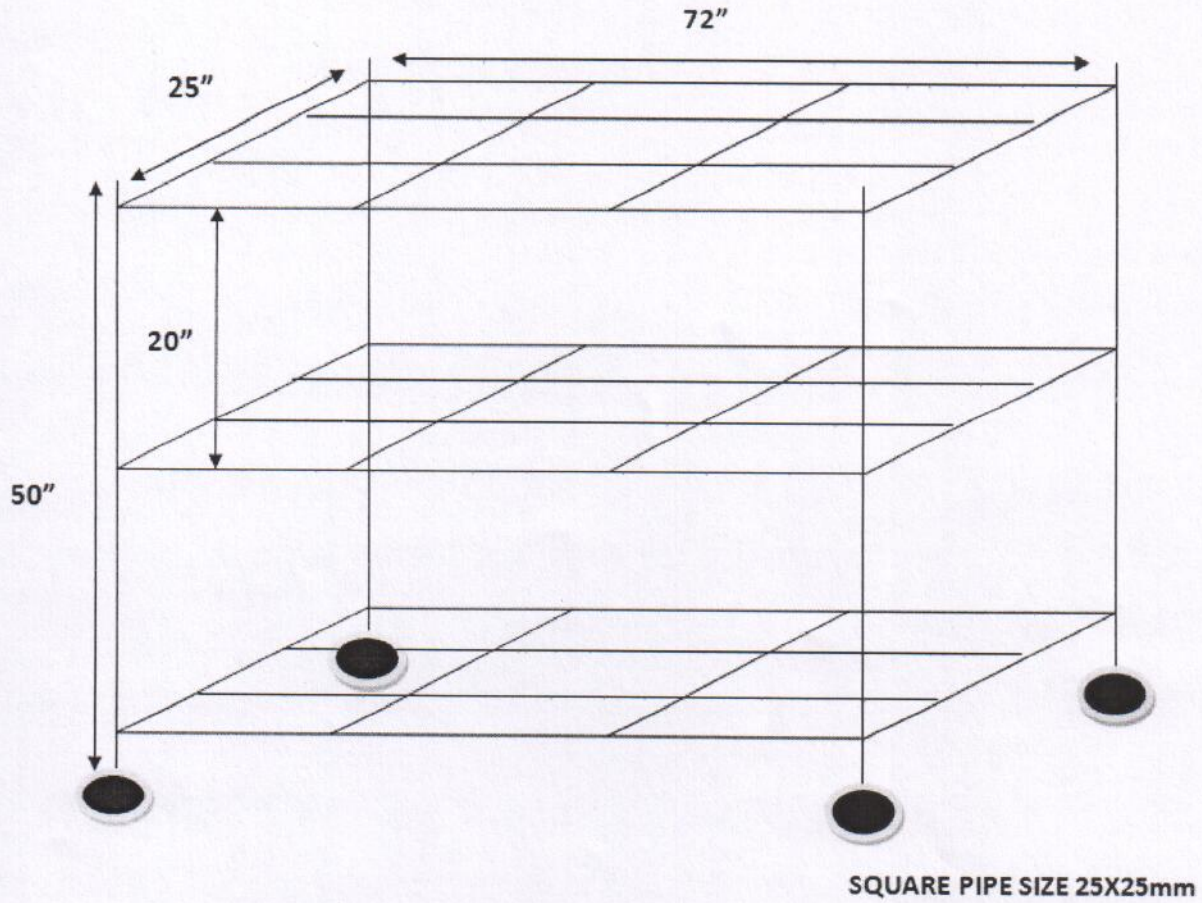

Specification for Racks (Stainless Steel)

Dimensions

Size Length : 72" (Clear Distance 20" between shelves), (03per Shelves)
Width : 25"
Height : 50"

Design : As per above

Frame:-

Pipe : 1 inch Square, 14 SWG, SS 304

Two central support pipes are welded in between along the length of the rack. Rack consists of **three shelves (03)** for holding the cages on each shelf. All shelves should be uniformly fabricated for easy movement of cage. Finishing of Rack Stainless Steel Mirror Finish (without any sharp corner)

Wheels

Size : 125 mm

Heavy duty Nylon/Polyurethane wheel material having frame of Stainless Steel to be bolted with rack bottom. Two (02) wheels with Lock and two (02) wheels without Lock.

Material: AISI (SS 304) quality stainless steel square pipe.

(Mr. Rakesh Kumar)
Technical Officer, CAF

(Dr. P.K. Yadav)
Sr. Vety. Officer, CAF

(Dr. S.S. Chauhan)
Professor-In-Charges, CAF



डॉ. प्रदीप कुमार यादव/Dr. Pardeep Kumar Yadav
वरिष्ठ पशु चिकित्सा अधिकारी/Senior Veterinary Officer
केंद्रीय पशु सुविधा/Central Animal Facility
अ.भा.आ.सं. नई दिल्ली-110029/AIIMS New Delhi-110029



डॉ. श्याम सिंह चौहान/Dr. Shyam Singh Chauhan
प्रभारी-आचार्य/Professor-in-Charge
केंद्रीय पशु सुविधा/Central Animal Facility
अ.भा.आ.सं. नई दिल्ली-29/A.I.I.M.S., New Delhi-29

CENTRAL ANIMAL FACILITY
ALL INDIA INSTITUTE OF MEDICAL SCIENCES

Date: 16/10/2020



The following documents are required against Rate Enquiry No.02/ Racks (Stainless Steel)/CAF/2020-21, (**Specification**)



Check list

1. Copy of latest sales Tax/service Tax Registration certificate/GST : -----
2. Authorization certificate for manufacturer/principal enclosed :-----
3. Earnest Money (Demand Draft/Pay order) according to requirement. No cash accepted against EMD :-----
4. Quality assurance certificate like ISI 9001-2000/ISO-9002/ FDA/CE/Equivalent, please specify. :-----
5. Stainless Steel Furniture Items GST HSN Code- 94021010 (18%) and also give the state code :-----
6. Quality assurance certificate of 304 Stainless Steel make (AISI Mark) :-----
7. List of users: Performance report/List of organization Supplied with the same equipment. :-----
8. Guarantee/ Warrantee for 5 years of Rack with wheels (Repair or Replace) :-----
9. Polishing and Buffing of Racks every 20 month for 5 years :-----
10. Affidavit/ undertaking that the firm has not been black Listed in the part by any hospital/organization. :-----
11. Affidavit/undertaking that the firm is not supplying the same item At the lowest rate quoted in the tender/RE to any Govt. Organization or any other Institute (false clause). :-----
12. Detail of name of beneficiary, Account no. of the beneficiary, IFCS code of the bank/branch enclosed at the page no. :-----

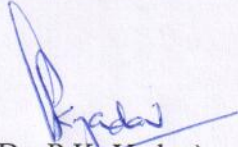
Submission of sample of Racks (Stainless Steel) after approval of the Price Bid.

(Mr. Rakesh Kumar)
Technical Officer, CAF

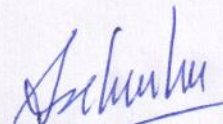
(Dr. P.K. Yadav)
Sr. Vety. Officer, CAF

डॉ. प्रदीप कुमार यादव/Dr. Pardeep Kumar Yadav
वरिष्ठ पशु चिकित्सा अधिकारी/Senior Veterinary Officer
केंद्रीय पशु सुविधा/Central Animal Facility
अ.भा.आ.सं.नई दिल्ली-110029/AIIMS New Delhi-110029

(Dr. S.S. Chauhan)
Professor-In-Charges, CAF

डॉ. श्याम सिंह चौहान/Dr. Shyam Singh Chauhan
प्रभारी-आचार्य/Professor-in-Charge
केंद्रीय पशु सुविधा/Central Animal Facility
अ.भा.आ.सं. नई दिल्ली-29/A.I.I.M.S., New Delhi-29